

# MCR716, MCR718

Preferred Device

## Sensitive Gate Silicon Controlled Rectifiers

### Reverse Blocking Thyristors

Designed for high volume, low cost, industrial and consumer applications such as motor control, process control, temperature, light and speed control.

#### Features

- Small Size
- Passivated Die for Reliability and Uniformity
- Low Level Triggering and Holding Characteristics
- Surface Mount Lead Form – Case 369C
- Epoxy Meets UL 94 V-0 @ 0.125 in
- ESD Ratings: Human Body Model, 3B > 8000 V  
Machine Model, C > 400 V
- Pb-Free Packages are Available

#### MAXIMUM RATINGS (T<sub>J</sub> = 25°C unless otherwise noted)

Rating	Symbol	Value	Unit
Peak Repetitive Off-State Voltage (Note 1) (T <sub>J</sub> = -40 to 110°C, Sine Wave, 50 to 60 Hz, R <sub>GK</sub> = 1 kΩ)	V <sub>DRM</sub> , V <sub>RRM</sub>	400 600	V
On-State RMS Current (180° Conduction Angles; T <sub>C</sub> = 90°C)	I <sub>T(RMS)</sub>	4.0	A
Average On-State Current (180° Conduction Angles; T <sub>C</sub> = 90°C)	I <sub>T(AV)</sub>	2.6	A
Peak Non-Repetitive Surge Current (1/2 Cycle, Sine Wave 60 Hz, T <sub>J</sub> = 110°C)	I <sub>TSM</sub>	25	A
Circuit Fusing Consideration (t = 8.3 msec)	I <sup>2</sup> t	2.6	A <sup>2</sup> sec
Forward Peak Gate Power (Pulse Width ≤ 1.0 μsec, T <sub>C</sub> = 90°C)	P <sub>GM</sub>	0.5	W
Forward Average Gate Power (t = 8.3 msec, T <sub>C</sub> = 90°C)	P <sub>G(AV)</sub>	0.1	W
Forward Peak Gate Current (Pulse Width ≤ 1.0 μsec, T <sub>C</sub> = 90°C)	I <sub>GM</sub>	0.2	A
Operating Junction Temperature Range	T <sub>J</sub>	-40 to +110	°C
Storage Temperature Range	T <sub>stg</sub>	-40 to +150	°C

Stresses exceeding Maximum Ratings may damage the device. Maximum Ratings are stress ratings only. Functional operation above the Recommended Operating Conditions is not implied. Extended exposure to stresses above the Recommended Operating Conditions may affect device reliability.

1. V<sub>DRM</sub> and V<sub>RRM</sub> for all types can be applied on a continuous basis. Ratings apply for zero or negative gate voltage; positive gate voltage shall not be applied concurrent with negative potential on the anode. Blocking voltages shall not be tested with a constant current source such that the voltage ratings of the devices are exceeded.



ON Semiconductor®

<http://onsemi.com>

SCRs  
4.0 AMPERES RMS  
400 – 600 VOLTS

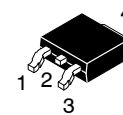

DPAK  
CASE 369C  
STYLE 4

#### MARKING DIAGRAM

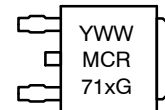

- Y = Year  
WW = Work Week  
MCR71x = Device Code  
x = 6 or 8  
G = Pb-Free Package

#### PIN ASSIGNMENT

1	Cathode
2	Anode
3	Gate
4	Anode

#### ORDERING INFORMATION

See detailed ordering and shipping information in the package dimensions section on page 2 of this data sheet.

Preferred devices are recommended choices for future use and best overall value.

# MCR716, MCR718

## THERMAL CHARACTERISTICS

Characteristic	Symbol	Max	Unit
Thermal Resistance, Junction-to-Case	$R_{\theta JC}$	3.0	$^{\circ}C/W$
Thermal Resistance, Junction-to-Ambient (Note 2)	$R_{\theta JA}$	80	$^{\circ}C/W$
Maximum Lead Temperature for Soldering Purposes 1/8" from Case for 10 Seconds	$T_L$	260	$^{\circ}C$

## ELECTRICAL CHARACTERISTICS ( $T_C = 25^{\circ}C$ unless otherwise noted.)

Characteristic	Symbol	Min	Typ	Max	Unit
----------------	--------	-----	-----	-----	------

### OFF CHARACTERISTICS

Peak Repetitive Forward or Reverse Blocking Current; $R_{GK} = 1\text{ k}\Omega$ (Note 3) ( $V_{AK} = \text{Rated } V_{DRM}$ or $V_{RRM}$ )	$I_{DRM}$	-	-	10	$\mu A$
	$I_{RRM}$	-	-	200	
					$T_C = 25^{\circ}C$
					$T_C = 110^{\circ}C$

### ON CHARACTERISTICS

Peak Reverse Gate Blocking Voltage ( $I_{GR} = 10\text{ }\mu A$ )	$V_{RGM}$	10	12.5	18	V
Peak Reverse Gate Blocking Current ( $V_{GR} = 10\text{ V}$ )	$I_{RGM}$	-	-	1.2	$\mu A$
Peak Forward On-State Voltage (Note 4) ( $I_{TM} = 5.0\text{ A Peak}$ ) ( $I_{TM} = 8.2\text{ A Peak}$ )	$V_{TM}$	-	1.3	1.5	V
		-	1.5	2.2	
Gate Trigger Current (Continuous dc) (Note 5) ( $V_D = 12\text{ Vdc}$ , $R_L = 30\text{ }\Omega$ )	$I_{GT}$	1.0	25	75	$\mu A$
		-	-	300	
Gate Trigger Voltage (Continuous dc) (Note 5) ( $V_D = 12\text{ Vdc}$ , $R_L = 30\text{ }\Omega$ )	$V_{GT}$	0.3	0.55	0.8	V
		-	-	1.0	
		0.2	-	-	
Holding Current (Note 3) ( $V_D = 12\text{ Vdc}$ , Initiating Current = 20 mA, $R_{GK} = 1\text{ k}\Omega$ )	$I_H$	0.4	1.0	5.0	mA
		-	-	10	
Latching Current (Note 3) ( $R_{GK} = 1\text{ k}\Omega$ ) ( $V_D = 12\text{ Vdc}$ , $I_G = 2.0\text{ mA}$ , $T_C = 25^{\circ}C$ ) ( $V_D = 12\text{ Vdc}$ , $I_G = 2.0\text{ mA}$ , $T_C = -40^{\circ}C$ )	$I_L$	-	-	5.0	mA
		-	-	10	
Total Turn-On Time (Source Voltage = 12 V, $R_S = 6\text{ k}\Omega$ , $I_T = 8\text{ A(pk)}$ , $R_{GK} = 1\text{ k}\Omega$ ) ( $V_D = \text{Rated } V_{DRM}$ , Rise Time = 20 ns, Pulse Width = 10 $\mu s$ )	$t_{gt}$	-	2.0	5.0	$\mu s$

### DYNAMIC CHARACTERISTICS

Critical Rate of Rise of Off-State Voltage ( $V_D = 0.67 \times \text{Rated } V_{DRM}$ , $R_{GK} = 1\text{ k}\Omega$ , Exponential Waveform, $T_J = 110^{\circ}C$ )	$dv/dt$	5.0	10	-	V/ $\mu s$
Repetitive Critical Rate of Rise of On-State Current ( $f = 60\text{ Hz}$ , $I_{PK} = 30\text{ A}$ , $PW = 100\text{ }\mu s$ , $dI_G/dt = 1\text{ A}/\mu s$ )	$di/dt$	-	-	100	A/ $\mu s$

- Case 369C, when surface mounted on minimum recommended pad size.
- Ratings apply for negative gate voltage or  $R_{GK} = 1\text{ k}\Omega$ . Devices shall not have a positive gate voltage concurrently with a negative voltage on the anode. Devices should not be tested with a constant current source for forward and reverse blocking capability such that the voltage applied exceeds the rated blocking voltage.
- Pulse Test: Pulse Width  $\leq 2\text{ ms}$ , Duty Cycle  $\leq 2\%$ .
- $R_{GK}$  current not included in measurements.

### ORDERING INFORMATION

Device	Package	Shipping†
MCR716T4	DPAK	2500 / Tape and Reel
MCR716T4G	DPAK (Pb-Free)	
MCR718T4	DPAK	
MCR718T4G	DPAK (Pb-Free)	

†For information on tape and reel specifications, including part orientation and tape sizes, please refer to our Tape and Reel Packaging Specifications Brochure, BRD8011/D.

# MCR716, MCR718

## Voltage Current Characteristic of SCR

Symbol	Parameter
$V_{DRM}$	Peak Repetitive Off-State Forward Voltage
$I_{DRM}$	Peak Forward Blocking Current
$V_{RRM}$	Peak Repetitive Off-State Reverse Voltage
$I_{RRM}$	Peak Reverse Blocking Current
$V_{TM}$	Peak On-State Voltage
$I_H$	Holding Current

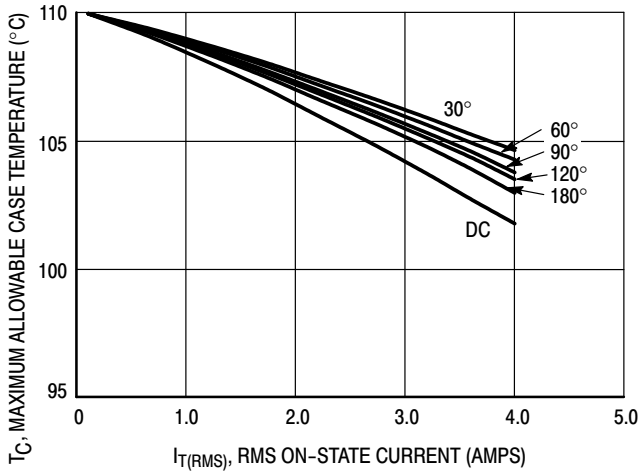
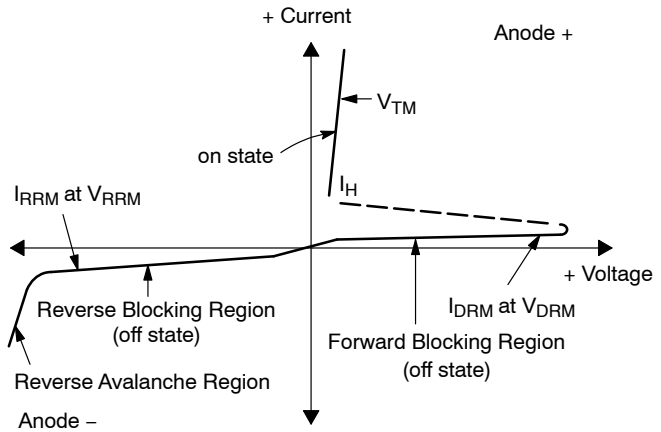

Figure 1. RMS Current Derating

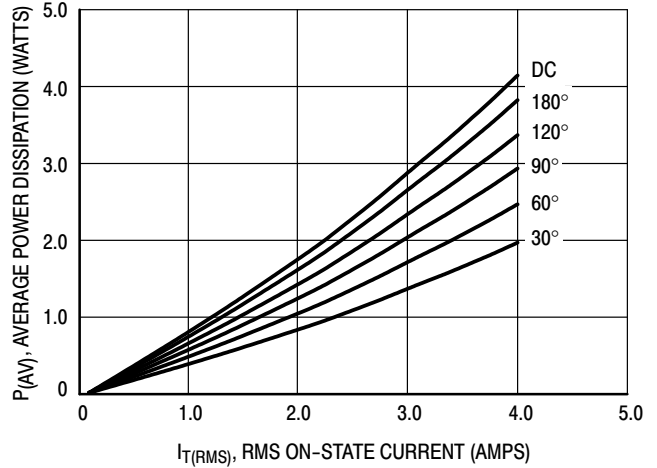

Figure 2. On-State Power Dissipation

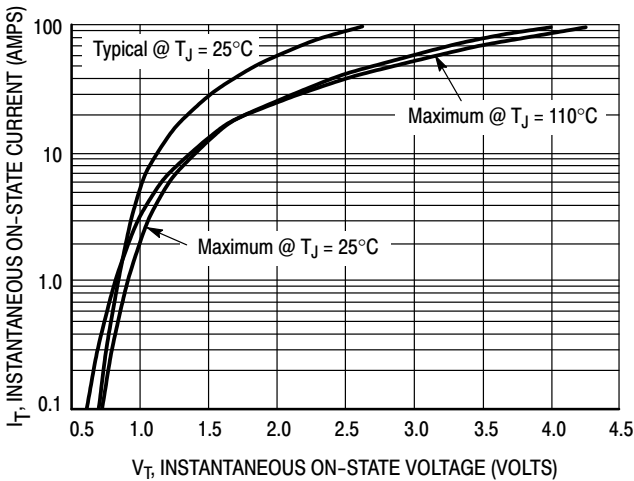

Figure 3. On-State Characteristics

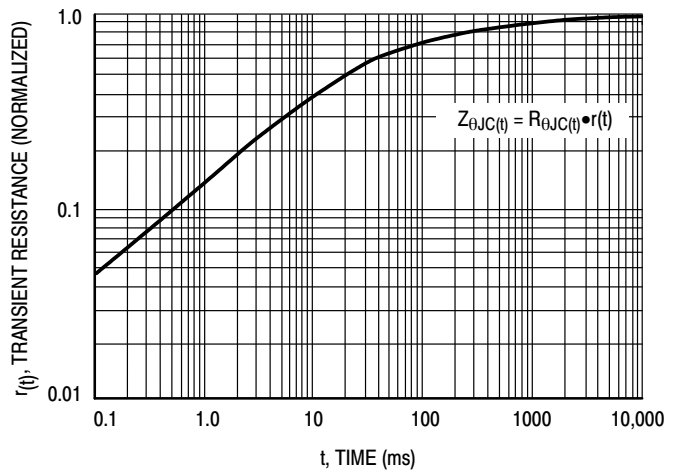

Figure 4. Transient Thermal Response

# MCR716, MCR718

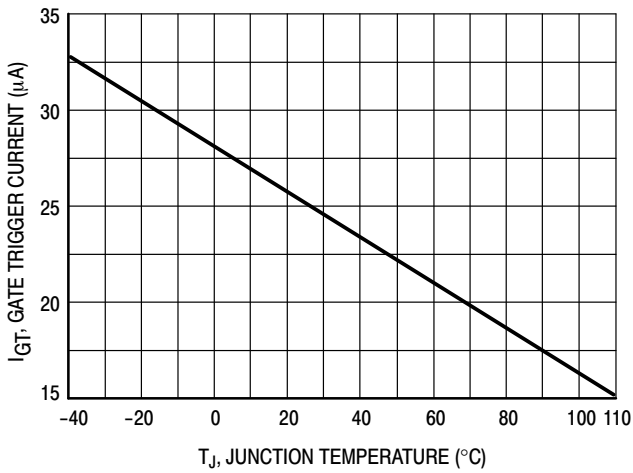

Figure 5. Typical Gate Trigger Current versus Junction Temperature

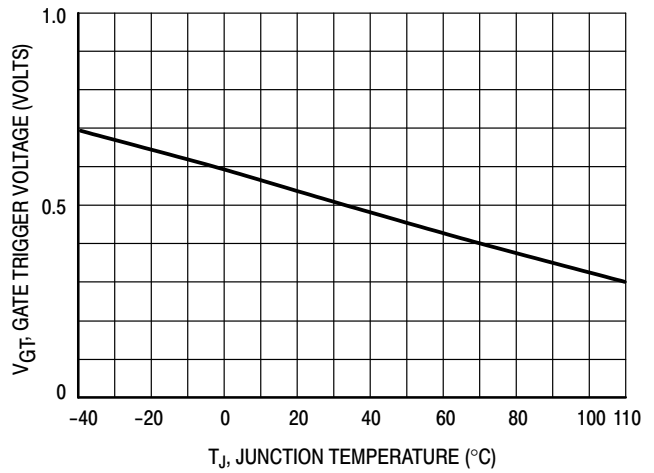

Figure 6. Typical Gate Trigger Voltage versus Junction Temperature

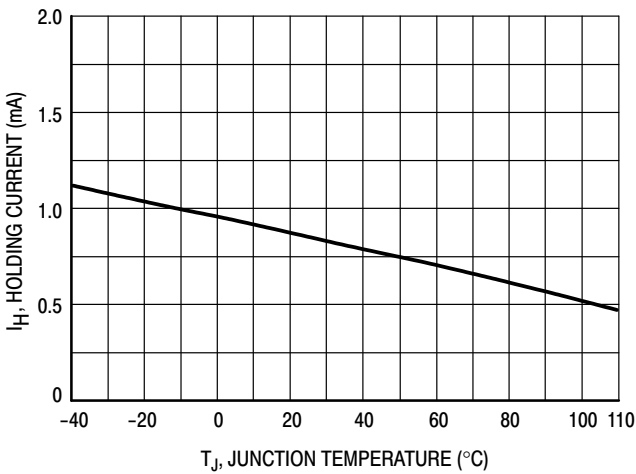

Figure 7. Typical Holding Current versus Junction Temperature

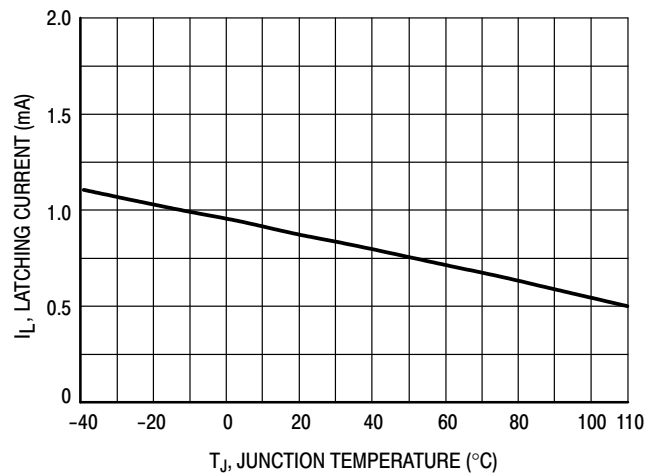
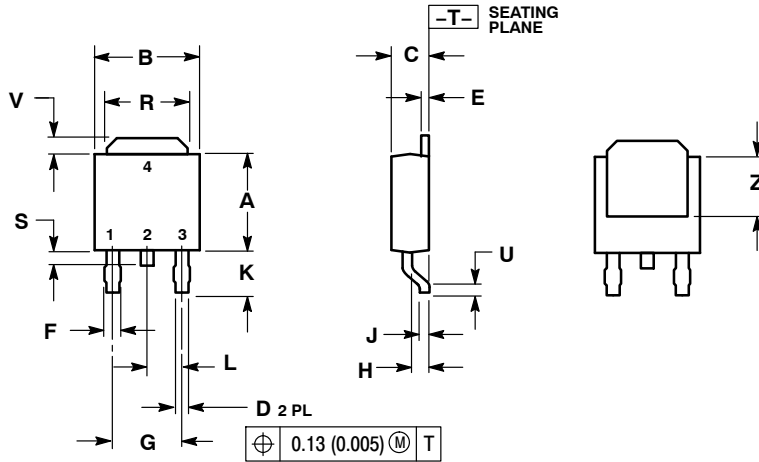

Figure 8. Typical Latching Current versus Junction Temperature

# MCR716, MCR718

## PACKAGE DIMENSIONS

### DPAK CASE 369C-01 ISSUE A



- NOTES:  
 1. DIMENSIONING AND TOLERANCING PER ANSI Y14.5M, 1982.  
 2. CONTROLLING DIMENSION: INCH.

DIM	INCHES		MILLIMETERS	
	MIN	MAX	MIN	MAX
A	0.235	0.245	5.97	6.22
B	0.250	0.265	6.35	6.73
C	0.086	0.094	2.19	2.38
D	0.027	0.035	0.69	0.88
E	0.018	0.023	0.46	0.58
F	0.037	0.045	0.94	1.14
G	0.180 BSC		4.58 BSC	
H	0.034	0.040	0.87	1.01
J	0.018	0.023	0.46	0.58
K	0.102	0.114	2.60	2.89
L	0.090 BSC		2.29 BSC	
R	0.180	0.215	4.57	5.45
S	0.025	0.040	0.63	1.01
U	0.020	---	0.51	---
V	0.035	0.050	0.89	1.27
Z	0.155	---	3.93	---

- STYLE 4:  
 PIN 1. CATHODE  
 2. ANODE  
 3. GATE  
 4. ANODE

### SOLDERING FOOTPRINT\*

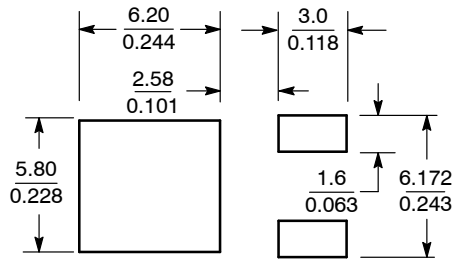

SCALE 3:1  $\left(\frac{\text{mm}}{\text{inches}}\right)$

\*For additional information on our Pb-Free strategy and soldering details, please download the ON Semiconductor Soldering and Mounting Techniques Reference Manual, SOLDERRM/D.

ON Semiconductor and are registered trademarks of Semiconductor Components Industries, LLC (SCILLC). SCILLC reserves the right to make changes without further notice to any products herein. SCILLC makes no warranty, representation or guarantee regarding the suitability of its products for any particular purpose, nor does SCILLC assume any liability arising out of the application or use of any product or circuit, and specifically disclaims any and all liability, including without limitation special, consequential or incidental damages. "Typical" parameters which may be provided in SCILLC data sheets and/or specifications can and do vary in different applications and actual performance may vary over time. All operating parameters, including "Typicals" must be validated for each customer application by customer's technical experts. SCILLC does not convey any license under its patent rights nor the rights of others. SCILLC products are not designed, intended, or authorized for use as components in systems intended for surgical implant into the body, or other applications intended to support or sustain life, or for any other application in which the failure of the SCILLC product could create a situation where personal injury or death may occur. Should Buyer purchase or use SCILLC products for any such unintended or unauthorized application, Buyer shall indemnify and hold SCILLC and its officers, employees, subsidiaries, affiliates, and distributors harmless against all claims, costs, damages, and expenses, and reasonable attorney fees arising out of, directly or indirectly, any claim of personal injury or death associated with such unintended or unauthorized use, even if such claim alleges that SCILLC was negligent regarding the design or manufacture of the part. SCILLC is an Equal Opportunity/Affirmative Action Employer. This literature is subject to all applicable copyright laws and is not for resale in any manner.

### PUBLICATION ORDERING INFORMATION

**LITERATURE FULFILLMENT:**  
 Literature Distribution Center for ON Semiconductor  
 P.O. Box 5163, Denver, Colorado 80217 USA  
**Phone:** 303-675-2175 or 800-344-3860 Toll Free USA/Canada  
**Fax:** 303-675-2176 or 800-344-3867 Toll Free USA/Canada  
**Email:** orderlit@onsemi.com

**N. American Technical Support:** 800-282-9855 Toll Free  
 USA/Canada  
**Europe, Middle East and Africa Technical Support:**  
 Phone: 421 33 790 2910  
**Japan Customer Focus Center**  
 Phone: 81-3-5773-3850

**ON Semiconductor Website:** [www.onsemi.com](http://www.onsemi.com)

**Order Literature:** <http://www.onsemi.com/orderlit>

For additional information, please contact your local Sales Representative